

S E R I E S [E] O N E





SERIES[E] ONE

Series[e] one offers many options and great freedom of choice to create your own solution. Series[e] one has been expanded with even more tables and more storage units. This means you can safely choose Series[e] one, regardless of the type of work tasks, the number of employees and the design of the premises. From a vast range of tabletops and underframes you can create an individual workplace or build large office landscapes – all the time with the needs of the user in focus. Then you can add loads of accessories to create a pleasant environment and further increase efficiency.



FUNCTIONS & OPTIONS



ROUND LEGS

The round legs are available in silver or white. With fixed or adjustable height. Covering sleeve (S), increased length (200 S) or castors (C) can be chosen as accessories. Legs with adjustable height are also available: 830–1030 mm. Table height: 724 mm, S: 650–850 mm, C: 724 mm. Silver adjustment screws.

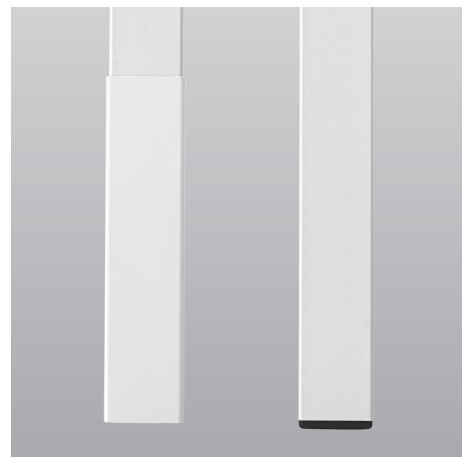

SQUARE LEGS

The square legs are available in silver or white. With fixed or adjustable height. Covering sleeve (S) and increased (200 S) can be chosen as accessories. Table height: 724 mm, S: 650–850 mm. Silver adjustment screws.



CONICAL LEGS

The conical legs are available in silver and white and are height adjustable. Choose covering sleeve (S) as an accessory. ORM200: table height 650–850 mm. ORMC: table height 680–760. Silver adjustment screws.

FUNCTIONS & OPTIONS

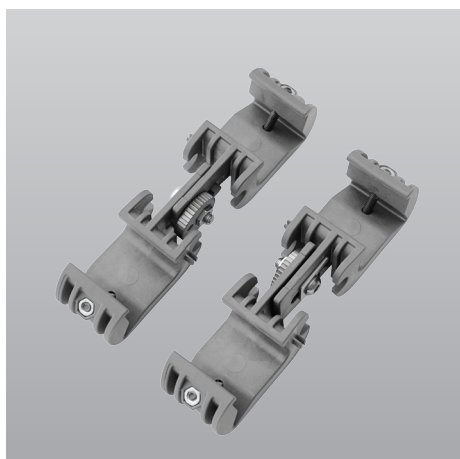

CONNECTORS

1COFF for connecting tables. Attached from beam to beam. Silver.



CONNECTORS

1COFT for connecting tables. Attached from beam to tabletop. Silver.



ACCESSORIES

The Series[e]one tables are fitted with a cable duct that is attached to the table frame.

DESKS

The extensive range of Series[e] one tabletops means there are many options and a great freedom of choice for you to create your own solution. From a vast range of tabletops and underframes you can create an individual workplace or build large office landscapes – all the time with the needs of the user in focus. When you design your own solution, we have specialised software which have a specialised software which provides you with a three-dimensional drawing of your new workplace. An easy way to plan.

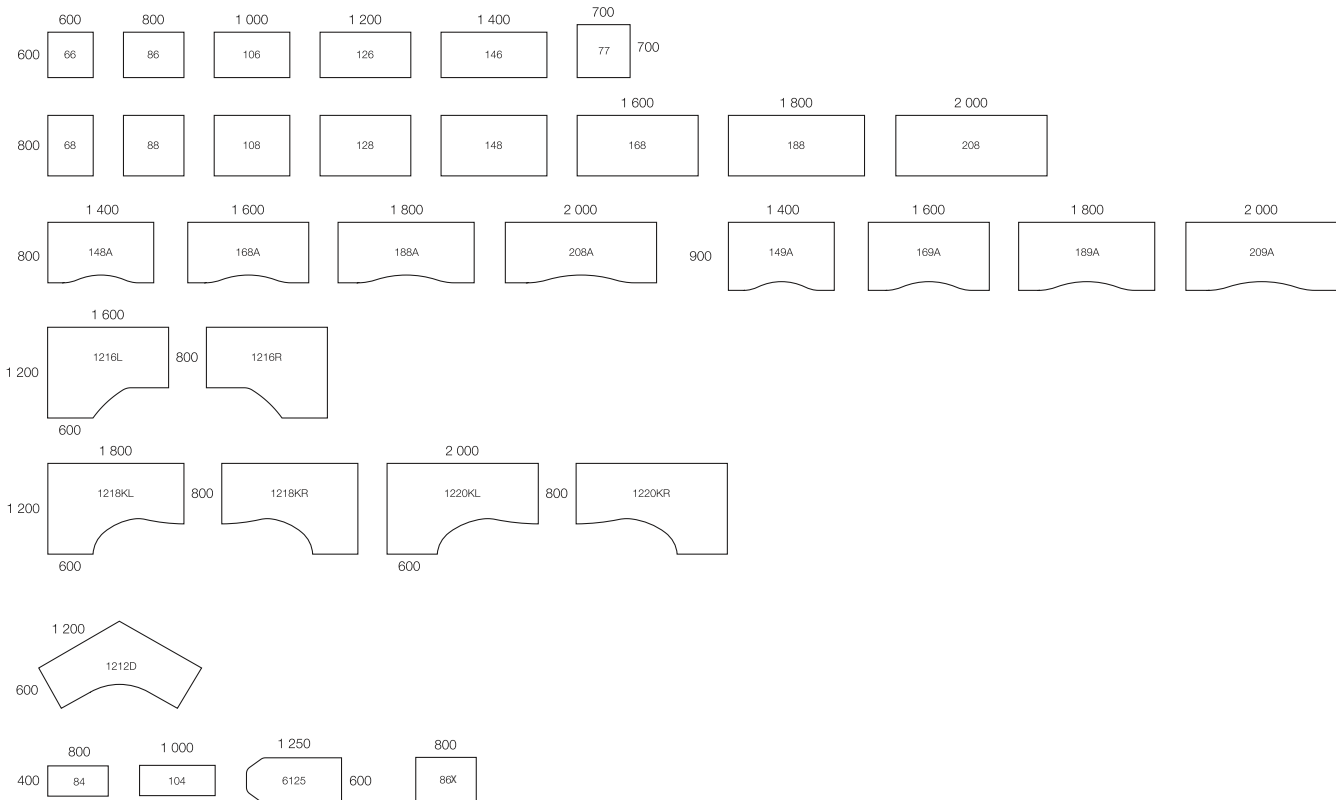

SERIES[E] ONE

TABLETOP 23 mm, chipboard with wood veneer and a solid wood tipping (beech, birch, oak), laminate (beech, birch, oak, white, light grey). **UNDERFRAME** Powder-coated steel **TABLE HEIGHT** Fixed with round legs (ORF) 724 mm. Adjustable with round legs (OR200 without sleeve, OR200S with sleeve) 650-850 mm. Adjustable with round legs sit/stand (ORS200 without sleeve, ORS200S with sleeve) 830-1,030 mm. Fixed with round legs with castors (ORC): 724 mm. Fixed with conical legs (OAF) 724 mm. Adjustable with conical legs and sleeve (OA200S): 650-850 mm. Adjustable with conical legs (ORM200) 650-850 mm. Adjustable with conical legs with castors (ORMC): 680-760 mm **OPTIONS** Panels, electrics tidy, cabling, computer accessories, local storage, etc. **SCALE** 1:100. **UNIT** mm.

MEETING TABLES

If you choose Series[e] one for your conference or meeting room or for break and restaurant areas, you have several different solutions and sizes to choose from.

PILLAR TABLE height 550 mm (EPL)

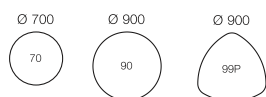

PILLAR TABLE height 724 mm (EPM)

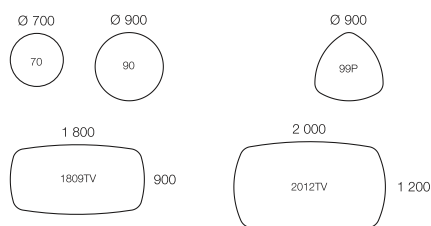

PILLAR TABLE height 1,100 mm (EPH, PP)

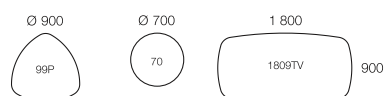

MEETING/CONFERENCE TABLE height 724 mm (PP)

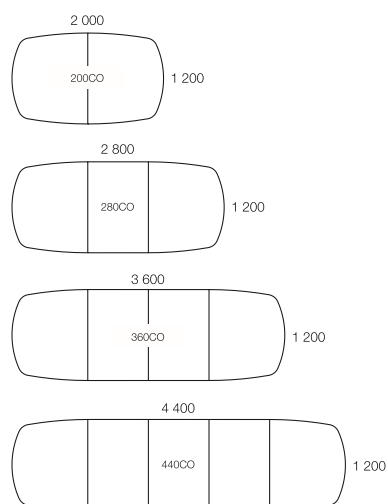

SERIES[E] ONE

TABLETOP 23 mm, chipboard with wood veneer and a solid wood lipping (beech, birch, oak), Laminate (beech, birch, oak, white, light grey). **UNDERFRAME** Pillar base in powder-coated steel (silver or white), steel footplate (dark grey). **TABLE HEIGHT** Fixed with pillar (EPL): 550 mm, (EPM): 724 mm, (EPH): 1,100 mm, (PP): 1,100 mm
OPTIONS Electrics tidy and cabling for conference tables. **SCALE** 1:100. **UNIT** mm.



BETTER AT WORK

We believe in making life better at work. At Kinnarps, we do more than just sell furniture. With products and services to match your needs, we deliver inspiring and effective workspace solutions to help your organisation prosper.
www.kinnarps.com

